

KENWOOD

DPX-400

DOUBLE DIN SIZED CD/CASSETTE RECEIVER

INSTRUCTION MANUAL

AMPLI-TUNER CD/CASSETTE DOUBLE TAILLE

MODE D'EMPLOI

RECEPTOR DE CD/CINTAS DE TAMAÑO DOBLE

MANUAL DE INSTRUCCIONES

KENWOOD CORPORATION

Take the time to read through this instruction manual.

Familiarity with installation and operation procedures will help you obtain the best performance from your new double din sized CD/cassette receiver.

For your records

Record the serial number, found on the back of the unit, in the spaces designated on the warranty card, and in the space provided below. Refer to the model and serial numbers whenever you call upon your KENWOOD dealer for information or service on the product.

Model DPX-400 Serial number _____

©B64-1476-00 (KW)

COMPACT
disc
DIGITAL AUDIO

Contents

Before use	
Warning.....	3
Safety precautions.....	5
Handling Compact discs.....	7
Buttons and Display	
Basic operations.....	8
Tuner features.....	8
Cassette player features.....	9
CD/External disc control features.....	9
Equalizer/Analyzer control features.....	10
Other features.....	10
Remote.....	11
Basic operations	
Power.....	11
Switching Modes.....	11
Volume.....	12
Attenuator.....	12
Loudness.....	12
Menu System.....	12
Tuner features	
Selecting Tuning Mode.....	13
Tuning.....	14
Station Preset Memory.....	14
Auto Memory Entry.....	14
Clean Reception System Circuit (CRSC).....	15
Switching Display for Tuner.....	15
Station Name Preset (SNPS).....	16
Station Name Preset Play (SNPP).....	17
Cassette player features	
Playing Cassette Tapes.....	17
Fast Forwarding and Rewinding Cassette Tapes.....	17
Using Dolby B Noise Reduction.....	18
Switching Tape Types.....	18
Blank Skip.....	18
Tape Advance.....	18
Music Repeat.....	18
CD/External disc control features	
Playing CDs.....	19
Playing other Disc mode.....	19
Switching Display Mode for Discs.....	20
Fast Forwarding and Reversing Disc Play.....	20
Track Search.....	20
Disc Search.....	21
Track Repeat.....	21
Disc Repeat.....	21
Track Scan.....	21
Disc Scan.....	22
Random Play.....	22
Magazine Random Play.....	22
Presetting Disc Names.....	23
Disc Name Preset Play (DNPP).....	24
Text / Title Scroll.....	24
Equalizer / Analyzer control features	
Preset Equalizer Selection.....	25
Demonstration of Spectrum Analyzer.....	25
Spectrum Analyzer Group Selection.....	26
Spectrum Analyzer Display Selection.....	26
Other features	
Audio Control Setting.....	27
Switching Preout.....	28
Touch Sensor Tone.....	28
Clock Display.....	29
Adjusting Time.....	29
Dimmer level adjustment.....	29
Basic operations of remote	
30	
Installation	
Accessories.....	32
Installation Procedure.....	32
Connecting Wires to Terminals.....	33
Installation (for Non-HONDA ACURA Car).....	34
Installation (for HONDA ACURA Car).....	34
Troubleshooting guide	
37	
Specifications	
41	

▲ Warning



Dear Customer:

Selecting fine audio equipment such as the unit you've just purchased is only the start of your musical enjoyment. Now it's time to consider how you can maximize the fun and excitement your equipment offers. This manufacturer and the Electronic Industries Association's Consumer Electronics Group want you to get the most out of your equipment by playing it at a safe level. One that lets the sound come through loud and clear without annoying blaring or distortion — and, most importantly, without affecting your sensitive hearing.

Sound can be deceiving. Over time your hearing "comfort level" adapts to higher volumes of sound. So what sounds "normal" can actually be loud and harmful to your hearing. Guard against this by setting your equipment at a safe level **BEFORE** your hearing adapts.

To establish a safe level:

- Start your volume control at a low setting.
- Slowly increase the sound until you can hear it comfortably and clearly, and without distortion.

Once you have established a comfortable sound level:

- Set the dial and leave it there.

Taking a minute to do this now will help to prevent hearing damage or loss in the future. After all, we want you listening for a lifetime.

We Want You Listening For A Lifetime

Used wisely, your new sound equipment will provide a lifetime of fun and enjoyment. Since hearing damage from loud noise is often undetectable until it is too late, this manufacturer and the Electronic Industries Association's Consumer Electronics Group recommend you avoid prolonged exposure to excessive noise. This list of sound levels is included for your protection.

Decible Level Example

30	Quiet library, soft whispers
40	Living room, refrigerator, bedroom away from traffic
50	Light traffic, normal conversation, quiet office
60	Air conditioner at 20 feet, sewing machine
70	Vacuum cleaner, hair dryer, noisy restaurant
80	Average city traffic, garbage disposals, alarm clock at two feet.

THE FOLLOWING NOISES CAN BE DANGEROUS UNDER CONSTANT EXPOSURE

90	Subway, motorcycle, truck traffic, lawn mower
100	Garbage truck, chain saw, pneumatic drill
120	Rock band concert in front of speakers, thunderclap
140	Gunshot blast, jet plane
180	Rocket launching pad

Information courtesy of the Deafness Research Foundation.



▲Warning**▲CAUTION**

Use of controls or adjustments or performance of procedures other than those specified herein may result in hazardous radiation exposure.

In compliance with Federal Regulations, following are reproductions of labels on, or inside the product relating to laser product safety.

KENWOOD CORPORATION
2967-3, ISHIKAWA-CHO,
HACHIOJI-SHI
TOKYO, JAPAN

KENWOOD CORP. CERTIFIES THIS EQUIPMENT
CONFORMS TO DHHS REGULATIONS NO.21 CFR
1040. 10, CHAPTER I, SUBCHAPTER J.

Location : Bottom Panel

FCC WARNING

This equipment may generate or use radio frequency energy. Changes or modifications to this equipment may cause harmful interference unless the modifications are expressly approved in the instruction manual. The user could lose the authority to operate this equipment if an unauthorized change or modification is made.

NOTE

This equipment has been tested and found to comply with the limits for a Class B digital device, pursuant to Part 15 of the FCC Rules. These limits are designed to provide reasonable protection against harmful interference in a residential installation. This equipment may cause harmful interference to radio communications, if it is not installed and used in accordance with the instructions. However, there is no guarantee that interference will not occur in a particular installation. If this equipment does cause harmful interference to radio or television reception, which can be determined by turning the equipment off and on, the user is encouraged to try to correct the interference by one or more of the following measures:

- Reorient or relocate the receiving antenna.
- Increase the separation between the equipment and receiver.
- Connect the equipment into an outlet on a circuit different from that to which the receiver is connected.
- Consult the dealer or an experienced radio/TV technician for help.

NOTE

This Class B digital apparatus complies with Canadian ICES-003.

Safety precautions

▲WARNING

To prevent injury or fire, take the following precautions:

- Insert the unit all the way in until it is fully locked in place. Otherwise it may fall out of place when jolted.
- When extending the ignition, battery, or ground wires, make sure to use automotive-grade wires or other wires with a 0.75mm² (AWG18) or more to prevent wire deterioration and damage to the wire coating.
- To prevent a short circuit, never put or leave any metallic objects (such as coins or metal tools) inside the unit.
- If the unit starts to emit smoke or strange smells, turn off the power immediately and consult your Kenwood dealer.
- Be careful not to drop the unit or subject it to strong shock.
The unit may break or crack because it contains glass parts.

▲CAUTION

To prevent damage to the machine, take the following precautions:

- Make sure to ground the unit to a negative 12V DC power supply.
- Do not open the top or bottom covers of the unit.
- Do not install the unit in a spot exposed to direct sunlight or excessive heat or humidity. Also avoid places with too much dust or the possibility of water splashing.
- Do not subject the faceplate to excessive shock, as it is a piece of precision equipment.
- When replacing a fuse, only use a new one with the prescribed rating. Using a fuse with the wrong rating may cause your unit to malfunction.
- To prevent a short circuit when replacing a fuse, first disconnect the wiring harness.
- Do not use your own screws. Use only the screws provided. If you use the wrong screws, you could damage the unit.

IMPORTANT INFORMATION

You cannot connect the unit directly to the following CD automatic changers. If you want to use older changers with the unit, follow the directions below according to the type of changer you own:

• **KDC-C200 / KDC-C300 / KDC-C400**

Use the extension cable and the control box attached to the CD changer, and the optional CA-DS100 converter cord.

• **KDC-C301 / KDC-C600 / KDC-C800 / KDC-C601 / KDC-C401**

Use the extension cable attached to the CD changer, and the optional CA-DS100 converter cord.

• **KDC-C100 / KDC-C302 / C205 / C705 / non-Kenwood CD changers**

Cannot be used with this model.

▲CAUTION

You can damage both your unit and the CD changer if you connect them incorrectly.

- Functions which can be used may differ depending on the model being connected.

Safety precautions

NOTE

- If you experience problems during installation, consult your Kenwood dealer.
- If the unit doesn't seem to be working right, try pressing the reset button first. If that does not fix the problem, consult your Kenwood dealer.

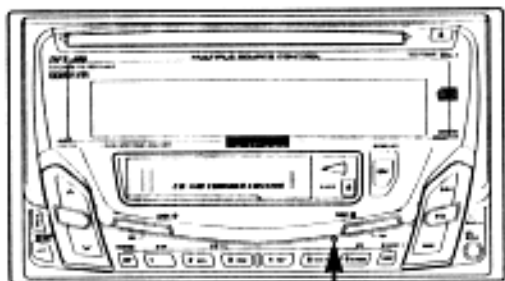

Reset button

Cleaning the Unit

If the front panel gets dirty, turn off the power and wipe the panel with a dry silicon cloth or soft cloth.

CAUTION

Do not wipe the panel with a hard cloth or a cloth dampened by volatile solvents such as paint thinner and alcohol. They can scratch the surface of the panel and/or cause the indicator letters to peel off.

Cleaning the Tape Head

After you have listened to many cassettes over a long period of time, magnetic powder from the tapes and dust accumulates on the tape head, causing noise and a deterioration in sound quality. Clean the tape head using a cleaning tape or cleaning kit designed for use in car audio systems.

Handling Cassette Tapes

- Do not play a cassette whose tape has gone slack. In such a case, wind it tight using a pencil or the like in one of the spools. Playing slack cassette tapes can result in the tape tangling around the capstan and/or pinch rollers, causing trouble.
- Do not play a deformed cassette or one whose label is starting to come off, as it can cause the unit to malfunction.
- Do not leave tapes in hot places, such as on dashboards and other spots exposed to direct sunlight, or near heater outlets. They can deform the cassette.
- Avoid using extremely long cassette tapes, such as 100-minute-long tapes. Such tapes are very thin, and can tangle easily around the pinch rollers or other parts inside the unit, causing unit failure.
- Remove a cassette tape from the unit when not listening to it for a while. If you leave a tape in the unit too long, it may stick to the tape head and cause unit malfunction.

Cleaning the CD Slot

As dust tends to accumulate in the CD slot, clean it every once in a while. Your CDs can get scratched if you put them in a dusty CD slot.



Lens Fogging

Right after you turn on the car heater in cold weather, dew or condensation may form on the lens in the CD player of the unit. Called lens fogging, CDs may be impossible to play. In such a situation, remove the disc and wait for the condensation to evaporate. If the unit still does not operate normally after a while, consult your Kenwood dealer.

Handling Compact discs

Playing a CD that is dirty, scratched or warped can cause the sound to skip and the unit to operate incorrectly, resulting in worsened sound quality. Take the following precautions to prevent your CDs from getting scratched or damaged.

Handling CDs

- Do not touch the recorded side of the CD (the side opposite the label) when holding it.



- Do not stick tape on either side of the CD.



Storing CDs

- Do not store CDs in areas exposed to direct sunlight (such as a car seat or the dashboard) or other hot places.
- Remove CDs from the unit when not listening to them for a while, and put them back in their cases. Do not pile up CDs that are removed from their cases or prop them against something.

Cleaning CDs

If a CD has gotten dirty, wipe it off gently using a commercially available cleaning cloth or a soft cotton cloth, starting from the center of the disc and moving outward. Do not clean CDs with conventional record cleaners, anti-static formulas, or chemicals such as paint thinner or benzene.

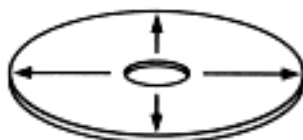

Checking New CDs for Burrs

When playing a new CD for the first time, check that there are not any burrs stuck to the perimeter of the disc or in the central hole. CDs with burrs stuck on them may not load properly or may skip while playing. Remove burrs using a ballpoint pen or a similar utensil.

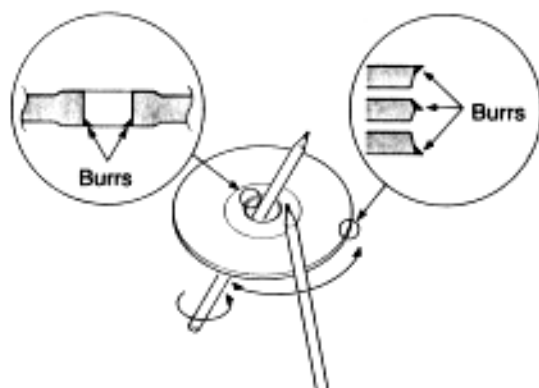

Do Not Load CD Accessories

Do not use commercially available CD accessories that can be loaded into the CD slot, such as stabilizers, protective sheets, or CD cleaning discs, since they can cause the unit to malfunction.

Removing the CD

Only remove the CD from the machine in a horizontal direction, holding it flat. You may damage the surface of the CD if you try pulling it down as it ejects.

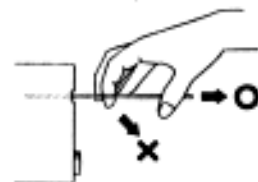

Do Not Use Special Shape CDs

- Be sure to use round shape CDs only for this unit and do not use any special shape CDs. Use of special shape CDs may cause the unit to malfunction.



- Be sure to use CDs with disc mark  only for this unit.

Do Not Use CDs with Sticker on the Labeled Side

Do not use the CD with the label sticker stuck on it. Using such a CD may cause the CD to be deformed and the sticker to peel off, resulting in malfunction of the unit.

Buttons and Display

Basic operations

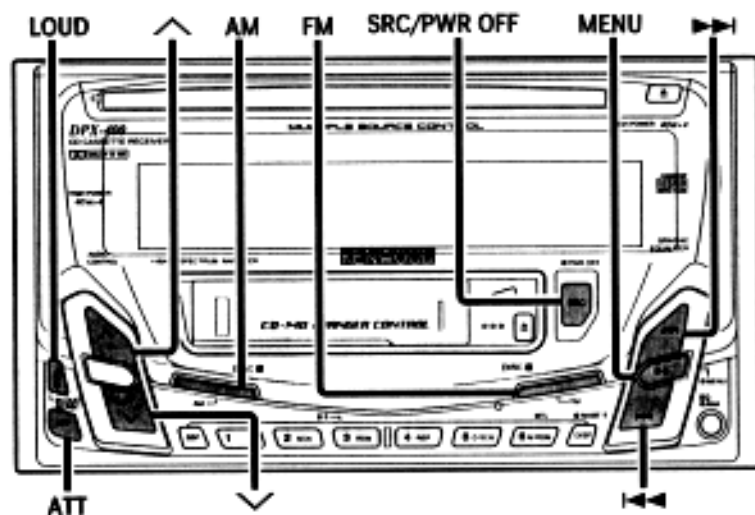

Tuner features

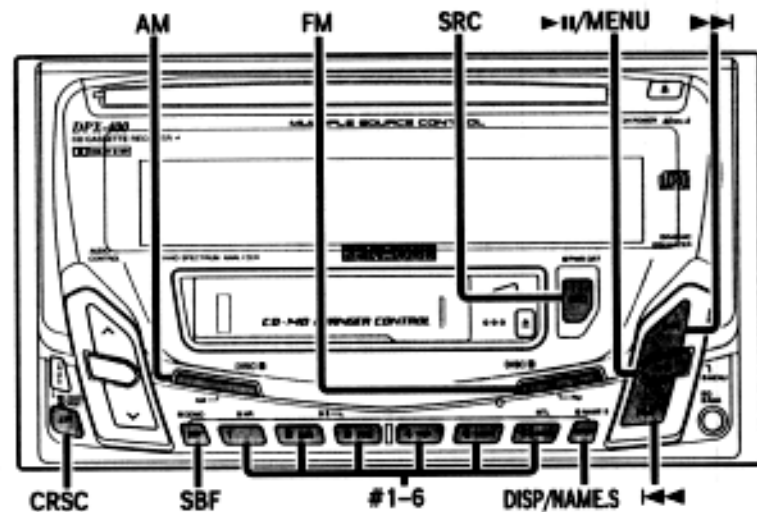

LOUD indicator



ATT indicator

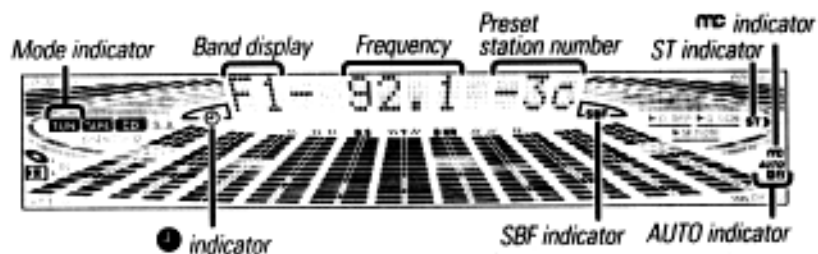

Cassette player features

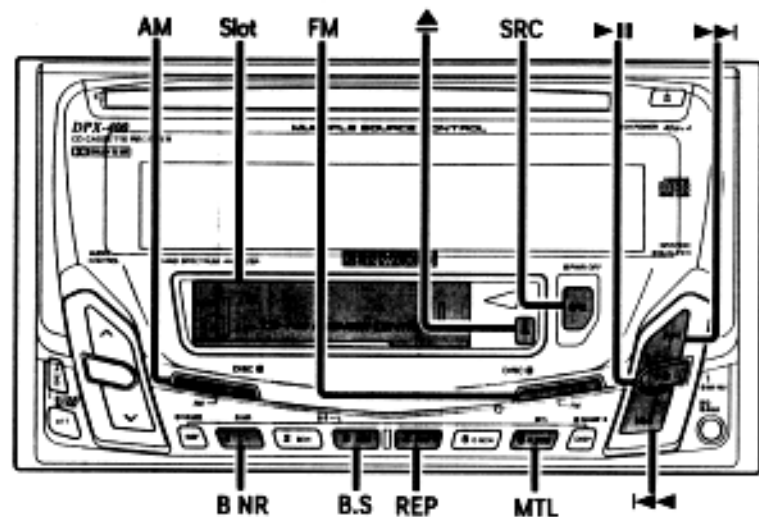

CD/External disc control features

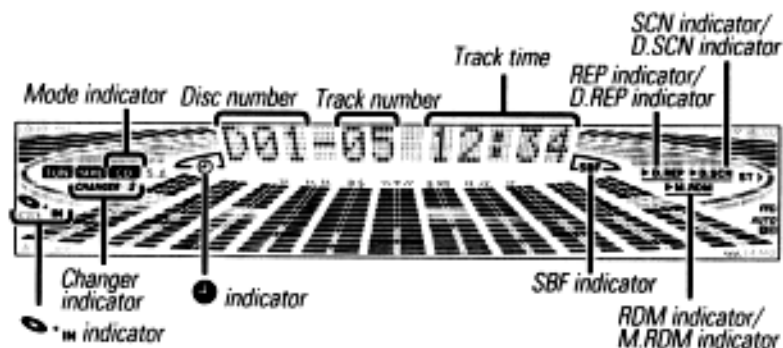
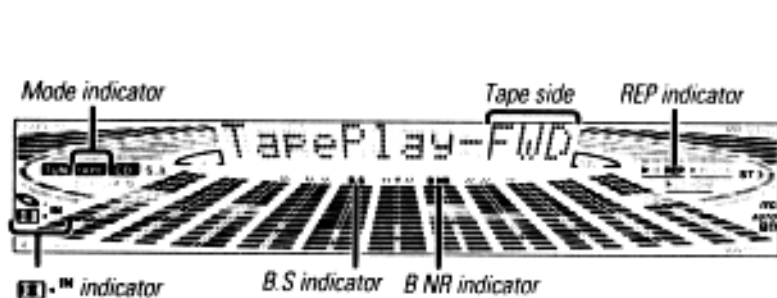
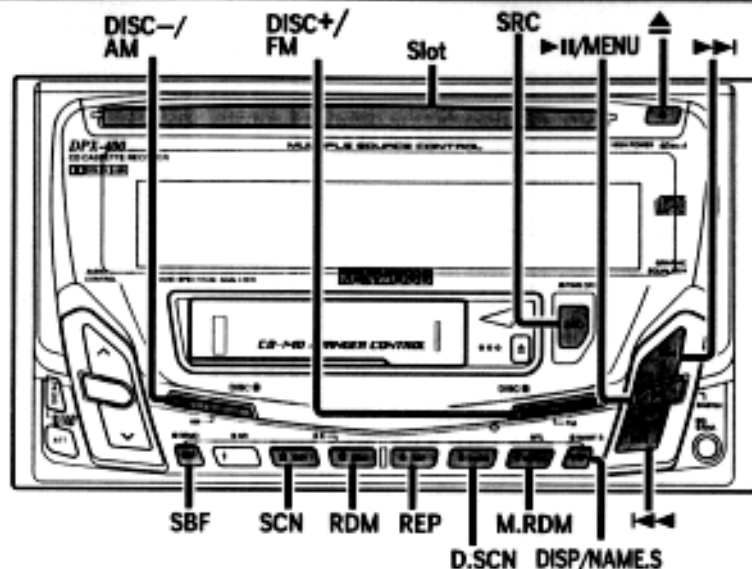

Buttons and Display

Equalizer / Analyzer control features

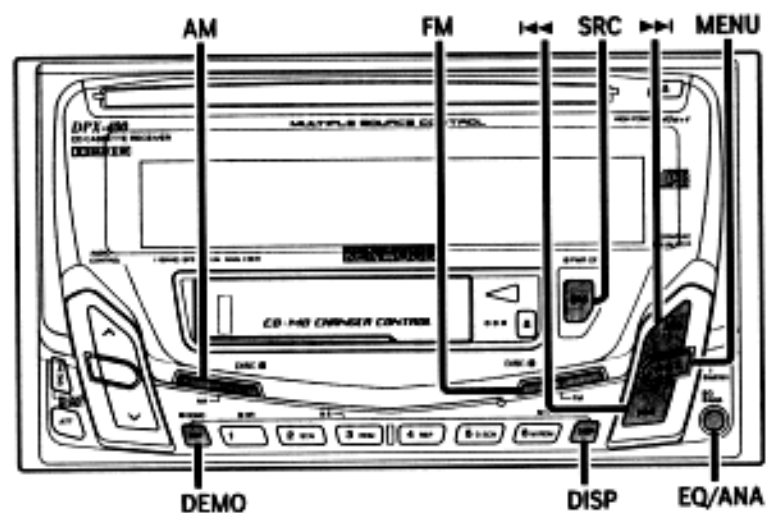

Other features

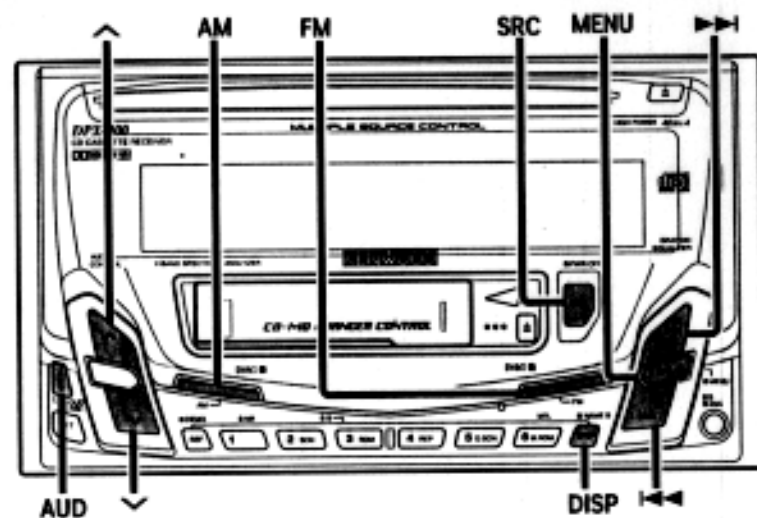

Equalizer/analyzer display

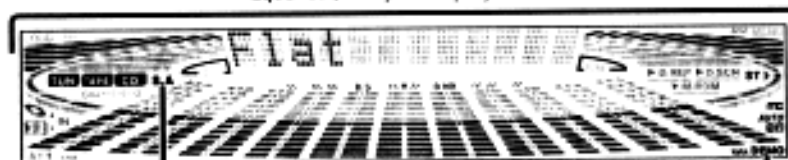

S.A indicator

DEMO indicator

Clock display



indicator

Remote

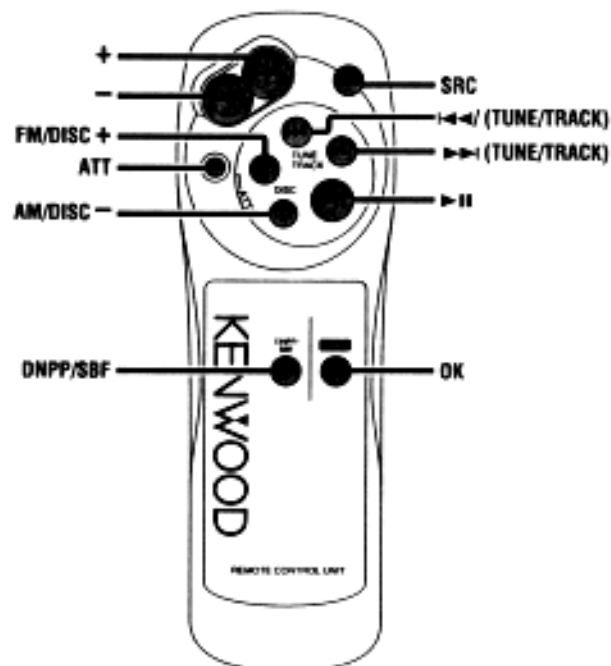

Basic operations (See page 8)

Power

Turning on the power:

Press the SRC (source) button.

NOTE

Turn the power on before carrying out the following procedures.

Turning off the power:

Press the PWR OFF button for at least one second.

Selecting ALL OFF mode:

Press the SRC button repeatedly and switch to "ALL OFF". When "ALL OFF" is displayed, the ALL OFF mode is activated. The ALL OFF mode turns all functions off while leaving the power to the unit on. Use this mode when you want to have the display illuminated but don't want to listen to anything.

Switching Modes

Switching Modes:

Each time you press the SRC (source) button, the mode switches as follows:

- ▼ Tuner mode
- ▼ Tape mode
- ▼ CD mode
- ▼ External disc control mode
- ▼ AUX mode
- ▼ ALL OFF mode

NOTE

- The mode switches to the next mode from any mode which cannot be used.
- The External disc control mode will differ depending on the unit that is connected.
- The AUX mode is available only when the changer / AUX switching adapter (KCA-S210A or CA-C1AX) or CD changer (KDC-CPS82 or KDC-CX82) is connected to this unit. During the AUX mode, "AUX INPUT" will show in the display. When the CA-C1AX is being used, the AUX Mode will replace the External Disc Control Mode.

Basic operations (See page 8)

Volume

Increasing Volume:

Press the \wedge button to turn up the volume.

Decreasing Volume:

Press the \vee button to turn down the volume.

Attenuator

This function allows you to turn down the volume quickly.

Turning Attenuator On/Off:

Press the ATT button to switch the attenuator on and off.

When the attenuator is on, the ATT indicator blinks.

When the attenuator is off, the volume returns to the original level.

NOTE

Turning the volume all the way down deactivates the attenuator function.

Loudness

This function amplifies low and high tones when the volume is turned down.

The LOUD indicator lights up when the loudness function is on.

Turning Loudness On/Off:

Press the LOUD button for at least one second to switch the loudness on and off.

Menu System

To accommodate a greater number of functions, a menu system has been employed for making settings. Press the MENU button to enter the menu mode and then display the function to make the setting. Details on each setting are explained separately in the corresponding function page.

- 1 Select the mode that you want to make the setting of the function.
- 2 Press the MENU button for at least one second. "Function Set" is displayed when the menu mode is entered. The function that you can adjust is indicated with the current settings displayed.
- 3 **Selecting function to set**
Press the $\blacktriangleright\blacktriangleright$ button to search through the functions until you see the one you want to adjust in the display. Press the $\blacktriangleleft\blacktriangleleft$ button to search through the functions backward.
Example: If you want to the setting of the touch sensor tone function from on to off, first search through the functions until you see "BEEP On" in the display.

- 4 **Changing setting for currently displayed function**

Press either the AM or FM button.

The setting will change for each function.

Example: The setting of the touch sensor tone will switch from on to off, and "BEEP Off" is displayed.

<In ALL OFF mode>

Function	Varieties of settings for each function (display)
Spectrum analyzer group selection	ANA. Silence ↔ ANA. Standard ↔ ANA. UP-Beat
Dimmer level adjustment	DIM STEP 1 ~ DIM STEP 5
Touch Sensor Tone	BEEP On ↔ BEEP Off
Switching Preout	Preout Rear ↔ Preout N-F

<In Tuner mode>

Function	Varieties of settings for each function (display)
Auto Memory Entry	AME Ready (start)
Selecting Tuning Mode	Auto 1 seek ↔ Auto 2 seek ↔ Manual Seek

<In External disc control mode>

Function	Varieties of settings for each function (display)
Text/Title Scroll	AT. SCRL On ↔ AT. SCRL Off

- 5 Ending the menu mode**
Press the MENU button.

Tuner features (See page 8)**Selecting Tuning Mode**

You can choose from three tuning modes: auto seek, preset station seek, and manual. The "AUTO 1" indicator lights up when auto seek tuning is selected, and the "AUTO 2" indicator lights when preset station seek tuning is selected.

- 1 Press the MENU button for at least one second. "Function Set" is displayed and the menu mode is turned on.
- 2 Keep pressing the ►► button until the tuning function appears in the display. Press the ◄◄ button to search in the other direction. The tuning method is displayed as "Auto 1", "Auto 2", or "Manual", referring respectively to auto seek tuning, preset station seek tuning, and manual tuning.
- 3 **Switching settings**
Press either the AM button or FM button to switch the tuning mode. The display and setting will change.
- 4 Press the MENU button to end the menu mode.

Tuner features (See page 8)

Tuning

- 1 Press the SRC (source) button repeatedly to select the tuner mode. "TUNER" is displayed when the tuner mode has been selected.
- 2 Press either the FM or AM button to select the band. Each time you press the FM button, the band switches between the FM1, FM2 and FM3. Press the AM button to select the AM band.
- 3
 - Auto Seek Tuning
Press the ►► button to seek higher frequencies.
Press the ◄◄ button to seek lower frequencies.
 - Preset station seek tuning
Press the ►► button to move to the next preset station (i.e., the one with the next highest number), and the ◄◄ button to move to the last preset station (i.e., the one with the next lowest number).
 - Manual Tuning
Press the ►► button to increase the frequency by one step.
Press the ◄◄ button to decrease the frequency by one step.

NOTE

The ST indicator lights up when stereo broadcasts are being received.

Station Preset Memory

Store the frequency of a station. You can then recall that station with a single touch of a button.

- 1 Select the band/station that you want to have stored.
- 2 Press the button (#1-6) that you want to use for the station, for at least two seconds.
The button number blinks once in the display to indicate that the data has been stored.

Recalling a Preset Station:

Press the preset station button (#1-6) for the desired station. The number of the recalled station is displayed.

NOTE

You can store six stations in each of the FM1, FM2, FM3, and AM bands.

Auto Memory Entry

You can automatically store all the receivable frequencies in the band currently being listened to, and then recall them with the touch of a button later. This function is especially useful when you are travelling and do not know what stations are available. Up to six frequencies can be stored this way.

- 1 Select the band for which you want to store stations.
- 2 Press the MENU button for at least one second.
"Function Set" is displayed and the menu mode is turned on.
- 3 Keep pressing the ►► button until "AME Ready" appears in the display.
Press the ◄◄ button to search in the other direction.
- 4 Press either the AM button or FM button for at least two seconds to start auto memory function.
The numbers of the preset station buttons are shown in order. When all the stations in a certain band are stored in the preset memory, the auto memory entry stops. The tuner then plays the last station received.

Recalling a Preset Station:

Press the preset station button (#1-6) for the desired station. The number of the recalled station is displayed.

Canceling Auto Memory Entry While It Is Operating:

Press the MENU button while auto memory entry is taking place to stop the process.

Clean Reception System Circuit (CRSC)

Temporarily have reception switched from stereo to mono to reduce multi-path noise when listening to the FM station. The  indicator lights up when CRSC is off.

Turning CRSC On/Off:

Press the CRSC button for at least one second to turn the function on and off.

NOTE

Strong electrical fields (such as from power lines) may cause unstable sound quality when CRSC is turned on. In such a situation, turn it off.

Switching Display for Tuner

You can change the display used when listening to the radio.

Changing the Display:

Each time you press the DISP button, the display changes as follows:

↓
Station frequency
↓
SNPS name (only when being preset)
↓
Clock

NOTE

- If you try to display a SNPS name that doesn't have one, "No Name" is displayed instead.
- The  indicator lights while the clock is displayed.

Tuner features (See page 8)

Station Name Preset (SNPS)

You can assign names to radio stations with the Station Preset Memory. Up to 30 stations can be assigned names.

- Adjust the frequency to the station whose name you want to enter.
- Press the NAME.S button for at least two seconds.
"Name Set" is displayed once the station name preset mode is entered.
The cursor will blink in the position where letters are entered.
- Press either the ◀◀ or ▶▶ button to move the cursor to the desired position.
The ◀◀ button moves the cursor to the left, and the ▶▶ button to the right.
You can also move the cursor left or right by pressing the ◀◀ or ▶▶ buttons, respectively, on the remote.
- Each time the ▶▶ button is pressed, the characters to be entered change as listed below.
Press the FM or AM button to display the desired character.
Characters that can be displayed are as follows.

Alphabet (upper case)/numerals/symbols:

A ~ Z 1-9 0 / + - * = < > |]

Alphabet (lower case)/numerals/symbols:

a ~ z 1-9 0 / + - * = < > []

- Continue steps 3 and 4 until all the characters are chosen for the name.

NOTE

You can enter up to 8 characters for each name.

- Press the NAME.S button.
The name of the station is stored in memory, and the Station Name Preset mode ends.
Also, if you make no input for 10 seconds, the name will be stored up to the point that you have entered, and the mode ends.

NOTE

- You can assign names to up to 30 FM/AM stations in all. If you try to enter more than that, the station name stored the earliest will be the first one erased.
- Station names remain stored even if the reset button is pressed.
- If you want to change the name of a station, first display the name of the station (following steps 1 and 2 above), then change the letter(s) that you want by following steps 3 and 4.

Station Name Preset Play (SNPP)

You can search for the station name for any station if its name has been preset using Station Name Preset.

- 1 Press the SBF button.
"SNPP" will be displayed once the station name preset play mode is entered. The SBF indicator lights during the station name preset play mode.
The names of the stations stored in the band currently listened to are displayed in the following order for five seconds each:
FM1, FM2, FM3, and AM.
Each time you press the ►► button, the station display switches in the forward direction.
Each time you press the ◄◄ button, the station display switches in the reverse direction.
Stations whose names have not been stored will be displayed as frequencies.

NOTE Changing the Displayed Band

Pressing the FM button switches between the FM1, FM2, FM3 and AM displays, in that order.
Pressing the AM button switches between the displays in the reverse direction.

- 2 **Once the name is displayed for the station you want to listen to**

Press the SBF button.
Reception starts of the displayed station, and the station name preset play mode ends.

Canceling mode during input:

Press the SBF button for at least one second.
The station name preset play mode is canceled.

Cassette player features (See page 9)

Playing Cassette Tapes

Loading and Playing Cassettes:

Holding the cassette with the tape exposed to the right, insert it in the slot. The tape will start playing.

The **IN** indicator lights up when a cassette has been loaded.

Playing Cassettes Already Loaded:

Press the SRC button repeatedly until the tape mode is obtained.

"TAPE" is displayed when the tape mode has been selected.

The tape will start playing.

Listening to the other side:

Press the ►|| button.

Tape play switches to the other side.

Ejecting Cassettes:

Press the ▲ button.

The tape stops playing and the cassette ejects.

NOTE

Remove a cassette from the unit when not listening to it for a while. If you leave it in the unit too long, the tape may stick to the tape head and cause the unit to malfunction.

Fast Forwarding and Rewinding Cassette Tapes

Fast Forwarding Tapes:

Press the FM button.

"FF" blinks during fast forwarding.

Rewinding Tapes:

Press the AM button.

"REW" blinks during rewinding.

Canceling:

Press the ►|| button.

Normal tape play will begin.

Cassette player features (See page 9)

Using Dolby B Noise Reduction

Listen to tapes recorded using Dolby B NR.

Turning Dolby B Noise Reduction On/Off:

Press the B NR button to switch Dolby B NR on and off.
The B NR indicator lights up when it is turned on.

*Dolby noise reduction manufactured under license from Dolby Laboratories Licensing Corporation.
"DOLBY" and the double-D symbol are trademarks of Dolby Laboratories Licensing Corporation.*

Switching Tape Types

Select type of tape being played.

Switching Tape Types:

Each time the MTL button is pressed, the tape type will be switched as follows:
"Metal On" ... CrO₂ (Type II) / FeCr (Type III) / Metal (Type IV)
"Metal Off" ... Normal tape (Type I)

Selecting the wrong tape type may cause sound quality to suffer.

Blank Skip

Automatically fast forward to the beginning of the next track when long blank spaces (10 seconds or more) are detected, continuing tape playback. The B.S indicator lights up when blank skip is turned on.

Turning Blank Skip On/Off:

Press the B.S button to switch blank skip on and off.

NOTE

- If the blank space contains a lot of noise, blank skip may not work right.
- Sections that are recorded at low levels may trigger blank skip if they last for 10 seconds or more.

Tape Advance

Rewinds to the beginning of the track currently being listened to (or fast forwards to the beginning of the next track), continuing tape playback.

Rewinding tape to the beginning of current track:

Press the ◀◀ button, and the tape will rewind to the beginning of the current track and automatically start playing again.

To advance to the beginning of the next track:

Press the ▶▶ button, and the tape will advance to the beginning of the next track and automatically start playing again.

NOTE

Tape advance "knows" where a track begins by detecting the blank space preceding it (the space between tracks). However, when the blank space lasts for less than four seconds or contains noise, this function may not operate correctly. Furthermore, sections that are recorded at low levels may trigger the function if they last for four seconds or more.

Music Repeat

Repeatedly plays the track currently being listened to.

Turning Music Repeat On/Off:

Press the REP button to switch music repeat on/off.
The REP indicator lights up when music repeat is turned on.

Canceling Music Repeat:

Press either the REP or ▶|| button.

NOTE

Music repeat "knows" where a track begins by detecting the blank space preceding it (the space between tracks). However, when the blank space lasts for less than four seconds or contains noise, this function may not operate correctly. Furthermore, sections that are recorded at low levels may trigger the function if they last for four seconds or more.

CD/External disc control features (See page 9)

- When a unit equipped with an O-N switch is to be connected, please also see the instruction manual of this unit. Set the O-N switch to "N". "N"-operation will be set.
- When a unit that is not equipped with an O-N switch, or the changer switching unit "KCA-S200" is connected, "O"-operation will be set.

"N"-operation:

- The disc title and track title of the CD text/MD can be displayed.
- The disc name will be displayed when the name has been registered to any connected unit with the Presetting Disc Names function, or when the playing unit contains a disc to which the disc title has been recorded.

"O"-operation:

- CD text cannot be displayed.
- The disc title and track title of the MD title can be displayed up to eight characters for each name.
- Regardless of the control unit, the characters that can be registered with the Presetting Disc Names function are "A-Z 0-9 /, +, -, *, =, <, >, |, '".
- The disc name will be displayed when the name has been registered to the playing unit with the Presetting Disc Names function.

NOTE

The CD text, Presetting Disc Names, and Disc Name Preset Play functions may not be operational depending on the unit.

Playing CDs

Play:

Holding the CD with the labeled side facing up, insert it in the slot. The CD will start playing.
The  indicator will light when a CD has been inserted.

Playing CDs Already Inserted:

Press the SRC button repeatedly to select the CD mode.
"CD" is displayed when the CD mode has been selected.
The CD will start playing.

Pausing and Restarting CD Play:

Press the  button to make the disc pause.
Press the same button again to start play again.

Stop / Eject:

Press the  button.
The CD stops playing and ejects from the slot.

CAUTION

Do not attempt to insert a CD into the slot if another one is already there.

NOTE

When you load a CD and eject it right away, the next time you try to insert the CD may not load. In such a situation, take the CD out for a moment and then reinsert it.

Playing other Disc mode

This function permits the connection of optional players and the playing of discs other than the loaded CD (in the current unit).

Playing Discs:

Press the SRC button repeatedly to select the external disc control mode.
The disc will start playing.

NOTE

The External disc control mode will differ, depending on the unit that is connected.

Mode Display Examples

- "DISC-CH"...when a disc changer is connected
- "DISC-CH1", "DISC-CH2"...when two disc changers are connected

Pausing and Restarting Disc Play:

Press the  button to make the disc pause.
Press the same button again to start play again.

NOTE

When one disc has finished playing its last track, the next disc in the changer will start playing. When the last disc in the changer has finished, the player will return to the first disc and start playing it.

CD/External disc control features (See page 9)

Switching Display Mode for Discs

Switch the display mode that appears while discs are playing.

Switching Time Display:

Each time you press the DISP button, the display mode during disc play switches as follows:

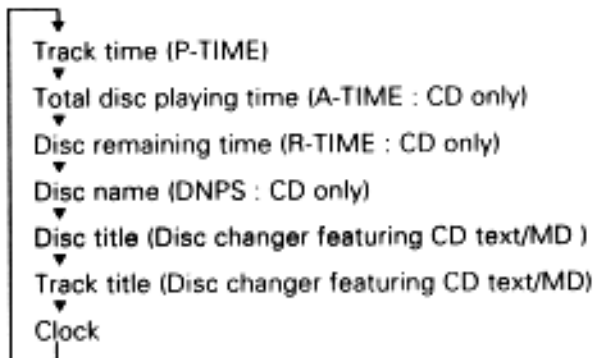

NOTE

- You can give names to discs through the presetting disc name function (see p. 23). Note that depending on the unit, display may not be possible.
- If you try to display the name of a disc that does not have one, "No Name" is displayed instead.
- When there is an attempt to display the title of a disc for which the disc title/track title has not been recorded, "No Text" is displayed for CD and "No Name" is displayed for MD.
- Depending on the type of characters of the CD Text, some characters may not be displayable.
- The ● indicator lights while the clock is displayed.

Fast Forwarding and Reversing Disc Play

Fast Forwarding Disc Play:

Hold down on the ►► button.
Release your finger to play the disc at that point.

Reversing Disc Play:

Hold down on the ◀◀ button.
Release your finger to play the disc at the point.

NOTE

You cannot use reverse play between tracks depending on the model being connected. Instead, the reverse play function is canceled when it reaches the beginning of a track, at which point normal play will automatically resume.

Track Search

Search forward or backward through the tracks on the disc until you reach the one that you want to listen to.

Making a Reverse Track Search:

Press the ◀◀ button to display the desired track number.
Press once to search back to the beginning of the current track, twice to search back to the beginning of the previous track, and so forth.
Play starts at the beginning of the displayed track number.

NOTE (for disc changers)

Pressing the ◀◀ button while listening to track 1 will only search back to the beginning of that track. The reverse search is not "recycled" to the last track on the disc.

Making a Forward Track Search:

Press the ►► button to display the desired track number.
Press once to fast forward to the next track, twice to fast forward to the track after that, and so forth.
Play starts at the beginning of the displayed track number.

NOTE (for disc changers)

You cannot make a forward track search when listening to the last track on a disc.

Disc Search

Search forward or backward through the discs in a disc changer.

Making a Reverse Disc Search:

Press the DISC- button to display the desired disc number. Each time the button is pressed, the displayed disc number decreases by one. Play starts at the beginning of the displayed disc.

Making a Forward Disc Search:

Press the DISC+ button to display the desired disc number. Each time the button is pressed, the displayed disc number increases by one. Play starts at the beginning of the displayed disc.

NOTE

Load is displayed when discs are being exchanged on the disc changer.

Track Repeat

Repeat playing the track currently being listened to.

Turning Repeat Play On/Off:

Press the REP button to switch repeat play on and off. The REP indicator lights up when repeat play is turned on. The track number currently being heard blinks in the display.

NOTE

Repeat play is canceled when you stop playing the disc.

Disc Repeat

Repeat playing the disc currently being listened to.

Turning Disc Repeat Play On/Off:

Press the REP button for at least one second to switch disc repeat play on and off. The D.REP indicator lights up when disc repeat play is turned on. The disc number currently being heard blinks in the display.

NOTE

Repeat play is canceled when you stop playing the disc.

Track Scan

Successively play the beginning of each track on a disc until you find the track that you want to listen to.

Turning Track Scan On/Off:

Press the SCN button to switch track scan on and off. The SCN indicator lights up when track scan is turned on. The first 10 seconds of each track will be played, in order. The track number currently being heard blinks in the display.

Stopping to Listen to the Track Being Scanned:

Press the ►|| or SCN button again to stop the scan and keep on listening to a track normally.

NOTE

- Track scan is canceled when you stop playing a disc.
- Track scan only scans each track on a disc once.

CD/External disc control features (See page 9)

Function of disc changers

Disc Scan

Successively play the beginning of each disc on a changer until you find the one that you want to listen to.

Turning Disc Scan On/Off:

Press the D.SCN button to switch disc scan on and off. The D.SCN indicator lights up when disc scan is turned on. The first 10 seconds of each disc will be played, in the order they are loaded on the changer. The disc number currently being heard blinks in the display.

Stopping to Listen to the Disc Being Scanned:

Press the ►|| or D.SCN button again to stop the scan and keep on listening to the disc normally.

NOTE

- Disc scan is canceled when you stop playing a disc.
- Disc scan only scans each disc on the changer once.
- "Load" is displayed when discs are being exchanged on the disc changer.

Random Play

Play all the tracks on the current disc in random order.

- 1 Press the RDM button to switch random play on and off. The RDM indicator lights up when random play is turned on. The track number will change over and over in the display as the next track is being selected. When the track has been selected, play will begin. The selected track number blinks in the display as it is being played.

NOTE (for disc changers)

When all the tracks on a certain disc have been played using random play, the next disc on the changer will start playing using the same function.

- 2 To change the track being heard, press the ►► button. Another track will be selected and played.

NOTE

Random play is canceled when you stop playing a disc.

Function of disc changers

Magazine Random Play

Play the tracks on all the discs in the disc changer in random order.

- 1 Press the M.RDM button to switch magazine random play on and off. The M.RDM indicator lights up when magazine random play is turned on. The disc and track numbers will change over and over in the display as the next track is being selected. When the disc/track has been selected, play will begin. The selected disc/track number blinks in the display as it is being played.

NOTE

This function is not available with the following models:
KDC-C200/C300/C400/C301/C401

- 2 To change the track being heard, press the ►► button. Another disc/track will be selected and played.

NOTE

- Magazine random play is canceled when you stop playing a disc.
- The time needed for random selection depends on the number of discs loaded in the disc magazine.

Presetting Disc Names**Store the names of discs to be displayed when played.**

- 1 Play the disc whose name you want to preset.

NOTE

- This function is not available for disc changers that do not feature the Disc Name Preset function.
- This procedure is not to be used to store the disc and track titles for MDs that you record.

- 2 Press the NAME.S button for at least two seconds. "Name Set" is displayed and the disc name preset mode is entered. The cursor blinks in the position where character input can be made.

- 3 Press either the ◀◀ or ▶▶ button to move the cursor to the desired position. The ◀◀ button moves the cursor to the left, and the ▶▶ button to the right.

- 4 Each time the ▶|| button is pressed, the characters to be entered change as listed below. Press the DISC+ or DISC- button to display the desired character. Characters that can be displayed are as follows.

Alphabet (upper case)/numerals/symbols:
A - Z 1-9 0 / + - * = < > | |

Alphabet (lower case)/numerals/symbols:
a - z 1-9 0 / + - * = < > | |

NOTE

The characters to be entered will not be switched if you press the ▶|| button, depending on the disc changer that is connected. In this case, only alphabet (upper case)/numerals/symbols can be displayed.

- 5 Continue steps 3 and 4 until all the characters are chosen for the name.

NOTE

You can enter up to eight characters for each name.

- 6 Press the NAME.S button. The disc name is stored and the disc name preset mode is canceled. If you make no entry in a 10-second period, the name will be stored with the characters input so far.

NOTE

- The number of discs whose names can be stored will differ depending on the disc changer that is connected. Please see your disc changer manual for details. Up to 10 CDs can be registered with this unit.
- Discs are identified by their total length and number of tracks. If another disc happens to have the same specifications as one that you have already stored a name for, the name will be displayed for it, too.
- If you want to change the name of a disc, repeat steps 1 and 2 to display the name, and then repeat steps 3 and 4 to input the changes.
- Each source (CD, DISC-CH1, DISC-CH2) has its own memory in which to store the disc names. Discs that have been disc name preset with the CD player will not have their disc name displayed when played on a CD changer.
- Disc names remain stored even if the reset button is pressed.
- This function is not available during clock display.

CD/External disc control features (See page 9)*Function of CD changers***Disc Name Preset Play (DNPP)**

If you have preset the name of a disc that you want to listen to in the disc changer, you can look for it by name and start playing it.

- 1 Press the SBF button.
"DNPP" will appear in the display, and the disc name preset play mode is entered. The SBF indicator lights during the disc name preset play mode.
The names of all the discs in the disc changer will appear successively in the display for five seconds each. Discs whose names have not been preset will appear as "No Name" in the display.

NOTE

- This function can only be used in disc changers that were manufactured or sold as of 1997. Also note that some units cannot provide a display unless the disc name preset has been made by the unit that is playing.
- Discs in the disc changer that have never been played before will appear as "NoAccess" when the disc names are displayed. When you cannot identify a disc because of the "NoAccess" display after inserting a disc magazine, try playing it using the disc scan or a similar function to display the disc name. Also note that "NoAccess" will be displayed when a disc has not been loaded.

Rapid display (forward / reverse):

Press the DISC+ or DISC- button.
Pressing the DISC+ button will rapidly display the preset names/disc titles in order.
Pressing the DISC- button will rapidly display the preset names/disc titles in reverse order.

2 When the name appears for the disc you want to play

Press the SBF button.
The disc whose name is displayed will be recalled, and the disc name preset play (DNPP) mode will end.

To cancel DNPP mode:

Press the SBF button for at least one second.
The disc name preset play (DNPP) mode will be canceled.

*Function of disc changers***Text/Title Scroll**

This function permits the text to be scrolled and the entire text to be displayed when the display is switched to the disc title/track title during disc play.

Switching the Text/Title Scroll On/Off:

- 1 Press the MENU button for at least one second.
"Function Set" is displayed and the menu mode is turned on. The function setting is indicated by "AT. SCRL On" or "AT. SCRL Off" in the display indicating that the current setting is on or off, respectively.
- 2 **Switching settings**
Press either the AM or FM button.
The display and setting will change.
- 3 Press the MENU button to end the menu mode.

NOTE

- Depending on the type of characters of the disc CD text/MD, some characters may not be displayable.
- Only units with a CD text/MD feature permit title display.

Equalizer/Analyzer control features (See page 10)

Preset Equalizer Selection

You can choose the equalizer from four settings whose sound qualities are preset to match music or vehicle characteristics.

- 1 Press the EQ/ANA button.
The preset equalizer selection mode is entered and the preset equalizer name currently set appears in the display.
- 2 Each time you press the EQ/ANA button, the preset equalizer switches as follows;

→ "Flat" ▶ "Pops" ▶ "Rock" ▶ "Classic" —

Flat ("Flat")	Reproduces the original sound without using equalizer effects.
Pops ("Pops")	Results in sound quality with full instrumentals and vocals.
Rock ("Rock")	Results in full sound quality with enhanced highs and lows.
Classic("Classic")	Optimum for playback of orchestra's configured like a pyramid.

- 3 Press the EQ/ANA button to end the preset equalizer selection mode.

Demonstration of Spectrum Analyzer

You can give a demonstration of the spectrum analyzer to know what displays this unit has.

Starting the Demonstration of Spectrum Analyzer:

Press the DEMO button for at least one second.

The DEMO indicator lights up during the demonstration. The spectrum analyzer display switches in sequence for 10 seconds each.

Canceling the Demonstration:

Press any button during the demonstration.

The demonstration is canceled and the original spectrum analyzer display returns.

NOTE

This function is not available during the ALL OFF mode.

Equalizer/Analyzer control features (See page 10)

Spectrum Analyzer Group Selection

You can choose from three Spectrum Analyzer Group : "ANA. Silence", "ANA. Standard", and "ANA. UP-Beat".

- 1 Press the SRC button repeatedly and switch the display to "ALL OFF" to enter the ALL OFF mode.
- 2 Press the MENU button for at least one second. "Function Set" is displayed and the menu mode is turned on.
- 3 Keep pressing the ►► button until the Spectrum Analyzer Group Selection function appears in the display. Press the ◄◄ button to search in the other direction. The function setting is indicated by "ANA. Silence" or "ANA. Standard" or "ANA. UP-Beat" in the display, indicating what the current spectrum analyzer group is.
- 4 **Switching settings**
Press either the AM button or FM button. The display and setting will change.
- 5 Press the MENU button to end the menu mode.

Spectrum Analyzer Display Selection

You can select the display in the analyzer group which you selected to enjoy sounds with eyes.

Switching the Spectrum Analyzer Display:

- 1 Press the EQ/ANA button for at least two seconds, the S.A indicator brinks. The analyzer name in the analyzer group being set in the Spectrum Analyzer Group Selection function of the menu mode is displayed.
- 2 Each time you press the DISP button, the analyzer display switches as follows;

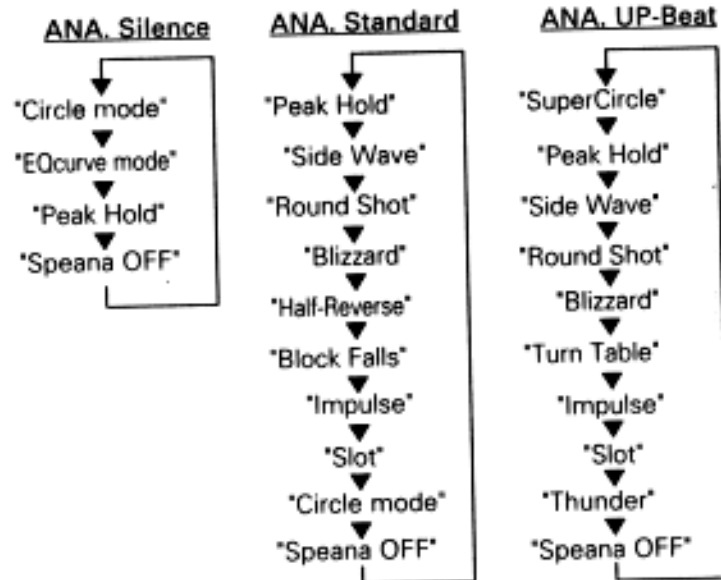

- 3 Press the EQ/ANA button to end the spectrum analyzer selection mode.

NOTE

If you make no button operation for 10 seconds, the spectrum analyzer display selection mode is automatically canceled.

Other features (See page 10)

Audio Control Setting

Adjust various parameters of sound quality.

- Press the AUD button to enter the control mode.
Each time the AUD button is pressed, the adjustment mode display changes as follows:

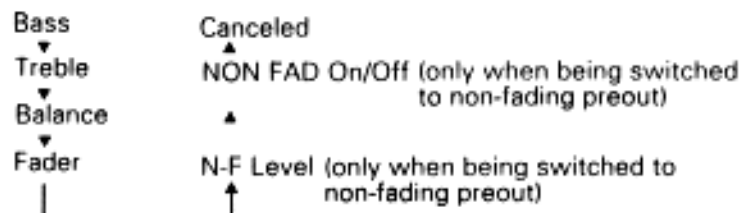

If you do not move to step 2 in five seconds, the control mode is automatically canceled.

NOTE Source tone memory

Each source (tape, FM, AM, CD and disc changer) has its own memory in which to store the bass and treble tone settings. The settings made for a particular source are recalled automatically whenever you use that source (for example, FM mode uses the tone settings made for FM, AM for AM, etc.).

- Press the ∇/\wedge buttons to adjust the mode shown in the display.
Use the following table as a guide for adjusting the settings in each mode.

Adjustment mode (Display)	Operation of Audio control button	
	∇ button	\wedge button
Bass ("Bass")	Bass decreased.	Bass increased.
Treble ("Treble")	Treble decreased.	Treble increased.
Balance ("Balance")	Left channel emphasized.	Right channel emphasized.
Fader ("Fader")	Rear channel increased.	Front channel increased.
Non-Fading Preout Level ("N-F")	Front and rear channels (including preout) emphasized.	Non-fading sound emphasized.
Non-Fading Output On/Off ("NON FAD")	You can set the non-fading sound output to either on or off. "NON FAD On" (ON) \leftrightarrow "NON FAD Off" (OFF)	

Other features (See page 10)

Switching Preout

Switch the preout between the rear and non-fading. The factory default is rear preout.

Switching the Preout:

- 1 Press the SRC button repeatedly and switch the display to "ALL OFF" to enter the ALL OFF mode.
- 2 Press the MENU button for at least one second. "Function Set" is displayed and the menu mode is turned on.
- 3 Keep pressing the ►► button until the Switching Preout function appears in the display. Press the ◄◄ button to search in the other direction. The function setting is indicated by "Preout Rear" or "Preout N-F" in the display, indicating that the current preout is rear or non-fading, respectively.
"Preout Rear" : Rear preout
"Preout N-F" : Non-fading preout
- 4 **Switching settings**
Press either the AM or FM button. The display and setting will change.
- 5 Press the MENU button to end the menu mode.

NOTE

The non-fading level adjusts with the volume difference between the non-fading output and the front/rear speaker output. The volume is adjusted lowering the volume of the front/rear speaker output without changing the volume of the non-fading output.

Touch Sensor Tone

This function produces a beep sound that accompanies button operation. It can be switched on or off.

Switching the Beep On/Off:

- 1 Press the SRC button repeatedly and switch the display to "ALL OFF" to enter the ALL OFF mode.
- 2 Press the MENU button for at least one second. "Function Set" is displayed and the menu mode is turned on.
- 3 Keep pressing the ►► button until the Touch Sensor Tone function appears in the display. Press the ◄◄ button to search in the other direction. The function setting is indicated by "BEEP On" or "BEEP Off" in the display, indicating that the current beep setting is on or off, respectively.
- 4 **Switching settings**
Press either the AM or FM button. The display and setting will change.
- 5 Press the MENU button to end the menu mode.

NOTE

The beep sound is not output from the preout jacks.

Clock Display

You can switch the clock display on or off during the ALL OFF mode.

Switching the Clock Display On/ Off during the ALL OFF mode:

Each time you press the DISP button, the clock display switches on or off.

NOTE

- The clock will not be displayed when the power of this unit is off nor when the vehicle ignition is off.
- The ● indicator lights while the clock is displayed.

Adjusting Time

Adjust the time.

- 1 When the time is not displayed, first press the DISP button to display the time.
- 2 While holding down the DISP button, press the ◀◀ or ▶▶ buttons to adjust the time.
The ▶▶ button adjusts the minutes and the ◀◀ button adjusts the hour.

Setting the minutes to "00":

While holding down the DISP button, press the FM button to set the minutes to "00".
Pressing these buttons while the minute is below "30" rounds it off, and while the minute is "30" or more rounds it up.

Dimmer level adjustment

You can adjust the Dimmer level of the unit separately when your car's light switch has been turned on or off.

NOTE

The dimmer function is not available if the dimmer wire is not connected.

To adjust the Dimmer level:

- 1 Press the SRC button repeatedly and switch the display to "ALL OFF" to enter the ALL OFF mode.
- 2 Press the MENU button for at least one second.
"Function Set" is displayed and the menu mode is turned on.
- 3 Keep pressing the ▶▶ button until the Dimmer level adjustment function appears in the display.
Press the ◀◀ button to search in the other direction.
The function setting is indicated by "DIM STEP #" in the display, indicating that the Dimmer level adjustment mode is on.
- 4 **Switching settings**
Press either the AM or FM button.
Press the FM button to change the setting values higher, and press the AM button to change them lower. Settings may be made from 1 to 5.
- 5 Press the MENU button to end the menu mode.

NOTE

The "#" display in the Dimmer level adjustment mode will differ depending on the setting. The initial setting value is "3".

Basic operations of remote (See page 11)

▲CAUTION

Do not set the remote on hot places such as above the dashboard.

Loading and Replacing the Batteries:

Use two "AAA"-size batteries.

Slide the cover while pressing downwards to remove it as illustrated.

Insert the batteries with the + and - poles aligned properly, following the illustration inside the case.

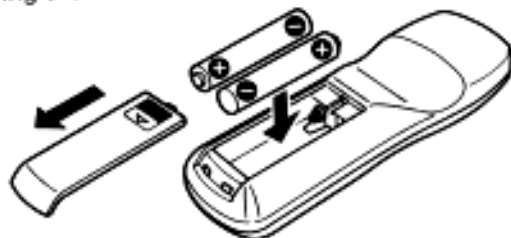

▲WARNING

Store unused batteries out of the reach of children. Contact a doctor immediately if the battery is accidentally swallowed.

NOTE

- The provided batteries are intended for use in operation checking, and their service life may be short.
- When the remote controllable distance becomes short, replace both of the batteries with new ones.

NOTE

A portion of the operations may not be possible, depending on the unit that is connected.

Basic operations

• VOLUME buttons

Press the + button to turn the volume up.
Press the - button to turn the volume down.

• SRC button

Each time you press the SRC button, the mode switches as follows;

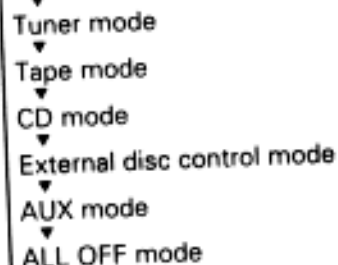

NOTE

- The mode switches to the next mode from any mode which cannot be used.
- The External disc control mode will differ depending on the unit that is connected.
- The AUX mode is available only when the changer / AUX switching adapter (KCA-S210A or CA-C1AX) or CD changer (KDC-CPS82 or KDC-CX82) is connected to this unit. During the AUX mode, "AUX INPUT" will show in the display. When the CA-C1AX is being used, the AUX Mode will replace the External Disc Control Mode.
- ATT button
Turns down the volume quickly.
To return the volume to its original level, press the button again. Turning down the volume all the way also cancels attenuation.

Tuner features

- **◀◀/▶▶ (TUNE) buttons**
Press the **◀◀** button to make decreasing seeks (using the preset tuning mode).
Press the **▶▶** button to make increasing seeks (using the preset tuning mode).
Use to move the cursor left or right during station name input.
- **AM/FM button**
Press the AM button to select the AM band.
Press the FM button to select and switch between FM1, FM2, and FM3 bands.
During station name input, selects digits and symbols.
- **OK button**
During Station name preset play mode, selects station.
- **DNPP/SBF button**
Enters and cancels the Station Name Preset Play mode.
- **▶|| button**
Selects the type of characters at the time of entering the station name.













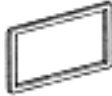

Cassette player features

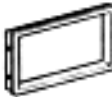
- **◀◀/▶▶ buttons**
Press the **◀◀** button to start play again at the beginning of the current track.
Press the **▶▶** button to start play at the beginning of the next track.
- **AM button**
Rewinds the tape.
- **FM button**
Fast forwards the tape.
- **▶|| button**
Plays the other side of the tape. When pressed during fast forward and rewind, this button stops the tape and starts playing it.

CD/External disc control features

- **◀◀/▶▶ buttons**
Press the **◀◀** button to search through the tracks backward.
Press the **▶▶** button to search through the tracks forward.
Use to move the cursor while entering disc name.
- **DISC buttons**
Press the DISC- button to search through the discs backward.
Press the DISC+ button to search through the discs forward.
Select numbers and symbols while entering disc name.
- **▶|| button**
When a disc is playing, this button pauses the play.
Press the same button again to start play again.
Selects the type of characters at the time of entering the disc name.
- **OK button**
Selects disc during the disc name preset play mode.
- **DNPP/SBF button**
Enters and cancels the Disc Name Preset Play mode.

Accessories

External view		External view	
 Number of Items	 Number of Items
①	6	⑧	1
②	1	⑨	6
③	1	⑩	6
④	1	⑪	2
⑤	1	⑫	1
⑥	1	⑬	1
⑦	1	⑭	4
		⑮	1

▲CAUTION

The use of any accessories except for those provided might result in damage to the unit. Make sure only to use the accessories shipped with the unit, as shown above.

Installation Procedure

1. To prevent a short circuit, remove the key from the ignition and disconnect the ⊖ battery.
2. Make the proper input and output wire connections for each unit.
3. Connect the speaker wires of the wiring harness.
4. Connect the wiring harness wires in the following order: ground, battery, ignition.
5. Connect the wiring harness connector to the unit.
6. Install the unit in your car.
7. Reconnect the ⊖ battery.
8. Press the reset button.

▲CAUTION

- If your car's ignition does not have an ACC position, connect the ignition wires to a power source that can be turned on and off with the ignition key. If you connect the ignition wire to a power source with a constant voltage supply, as with battery wires, the battery may die.
- If the fuse blows, first make sure the wires aren't touching to cause a short circuit, then replace the old fuse with one with the same rating.
- Do not let unconnected wires or terminals touch metal on the car or anything else conducting electricity. To prevent a short circuit, do not remove the caps on the ends of the unconnected wires or the terminals.
- Connect the speaker wires correctly to the terminals to which they correspond. The unit may be damaged or fail to work if you share the ⊖ wires or ground them to any metal part in the car.
- After the unit is installed, check whether the brake lamps, blinkers, wipers, etc. on the car are working properly.
- Insulate unconnected wires with vinyl tape or other similar material.
- Some disc changers need conversion cords for connection. See the section on "Safety Precautions" for details.
- Mount the unit so that the mounting angle is 30° or less.

Connecting Wires to Terminals

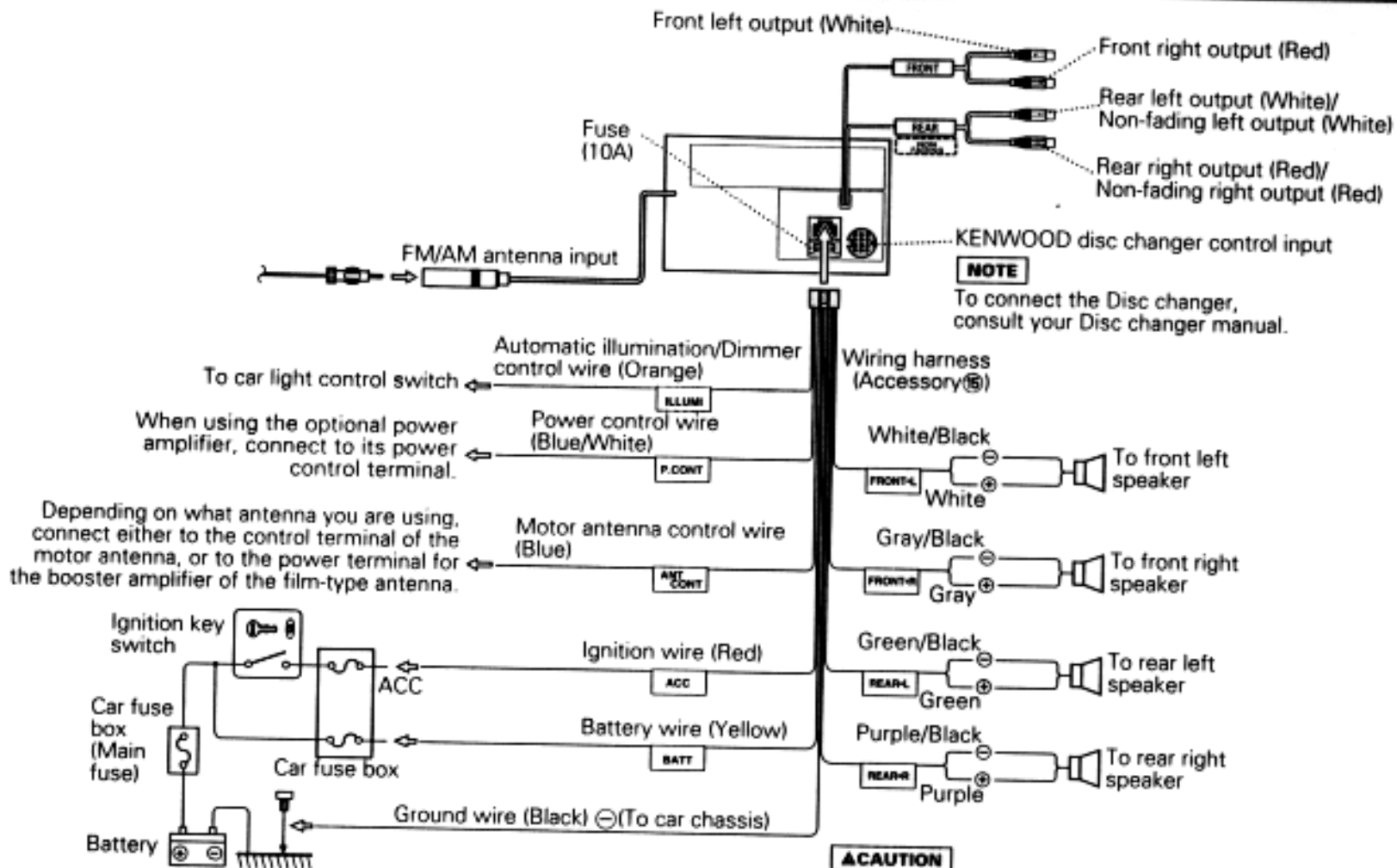

⚠ WARNING

If you connect the ignition wire (red) and the battery wire (yellow) to the car chassis (ground), you may cause a short circuit, that in turn may start a fire. Always connect those wires to the power source running through the fuse box.

⚠ CAUTION

When only two speakers are being connected to the system, connect the connectors either to both the front output terminals or to both the rear output terminals (do not mix front and rear). For example, if you connect the ⊕ connector of the left speaker to a front output terminal, do not connect the ⊖ connector to a rear output terminal.

Installation (for Non-HONDA ACURA Car)**CAUTION**

When performing a check of the CD operation prior to installation, place this unit in a horizontal position and perform a loading/eject of the CD.

Installation

Install onto the car bracket using the supplied screws (M5 x 6 mm). The holes of the car bracket to use will differ depending on the car model.

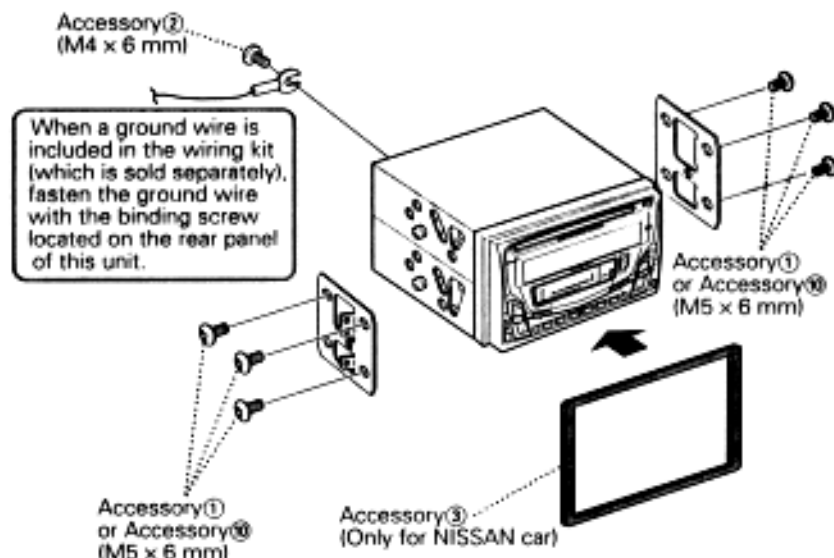
**Installation (for HONDA ACURA Car)**

The assembly and installation method will differ depending on the car model. Please perform the jobs in the following order.

ACCORD

Step1	Assembly 1
Step 2	Installation 2

LEGEND

Step1	Assembly 1
Step 2	Installation 3

CR-V

Step1	Assembly 2
Step 2	Installation 4

Other HONDA cars

Step1	Assembly 1
Step 2	Installation 1

■ Assembly 1

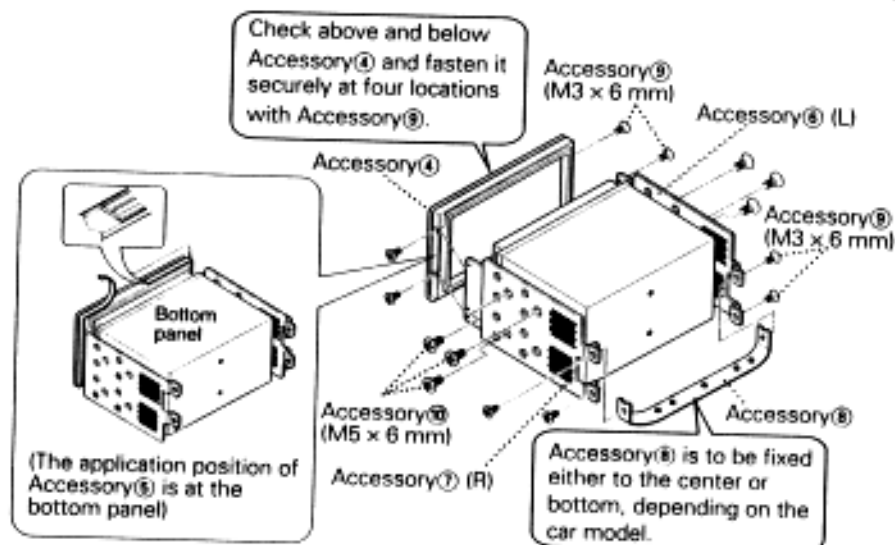

■ Assembly 2

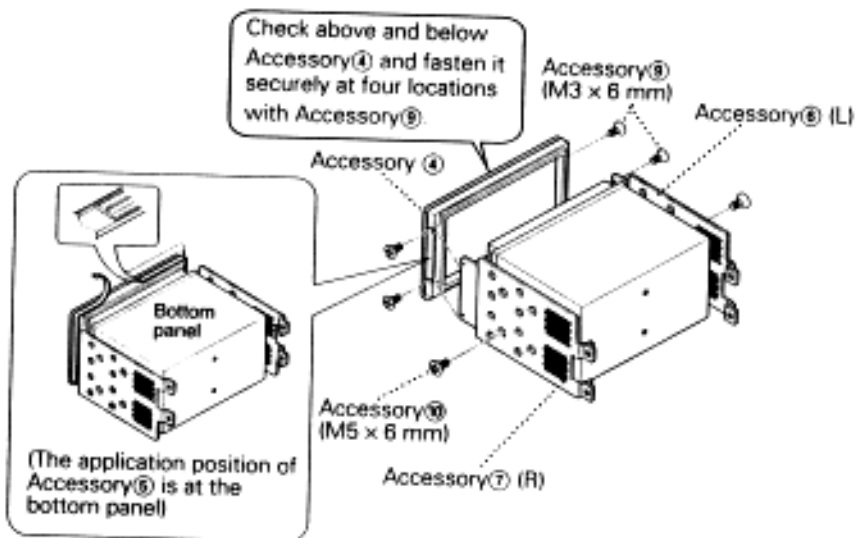

■ Installation 1

Remove the factory-installed car stereo and install the unit that was assembled in Assembly 1.

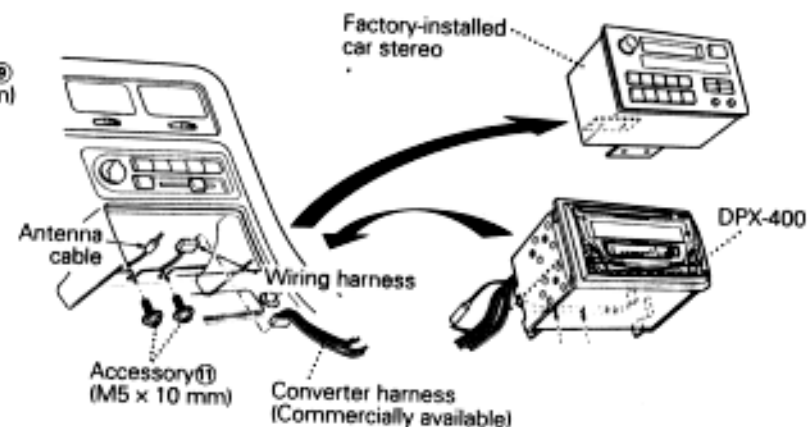

■ Installation 2 (for ACCORD)

- 1 Attach Accessory ⑫ to Accessory ⑧ which was assembled in Assembly 1.
- 2 Remove the factory-installed car stereo and install the unit.

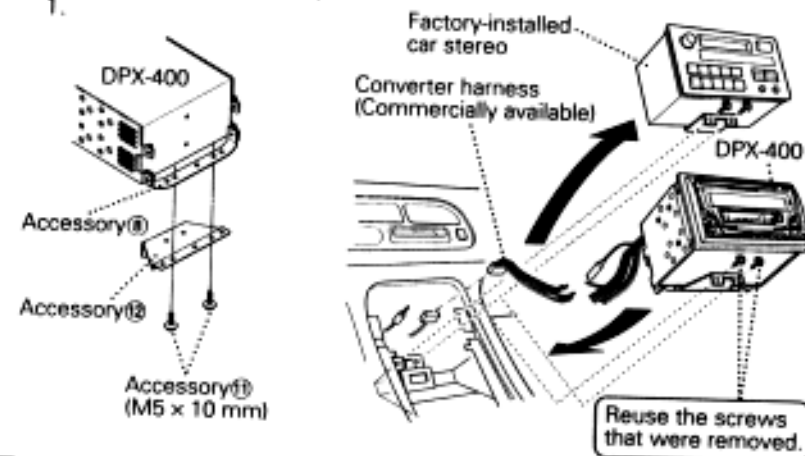

Installation (for HONDA ACURA Car)

■ Installation 3 (for LEGEND)

- 1 Attach Accessory[Ⓜ] to Accessory[Ⓟ] which was assembled in Assembly 1.
- 2 Remove the factory-installed car stereo and install the unit.

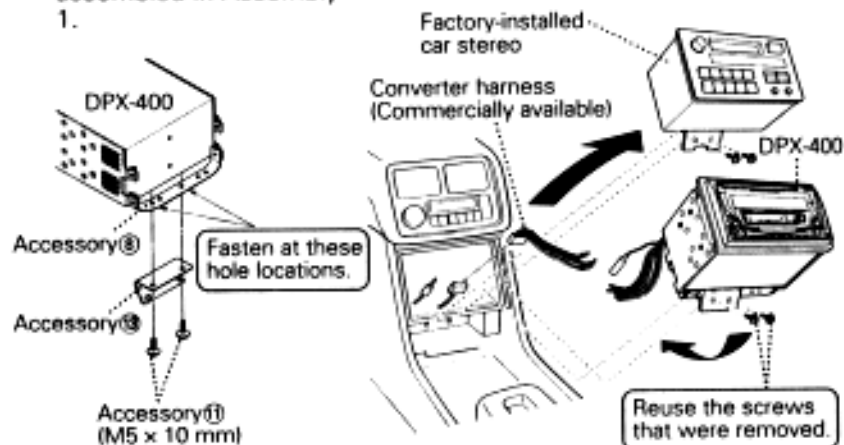

■ Installation 4 (for CR-V)

- 1 Use Accessory[Ⓜ] to mount the car bracket to the center panel which was removed.
- 2 Use Accessory[Ⓟ] to attach the unit which was assembled in Assembly 2.

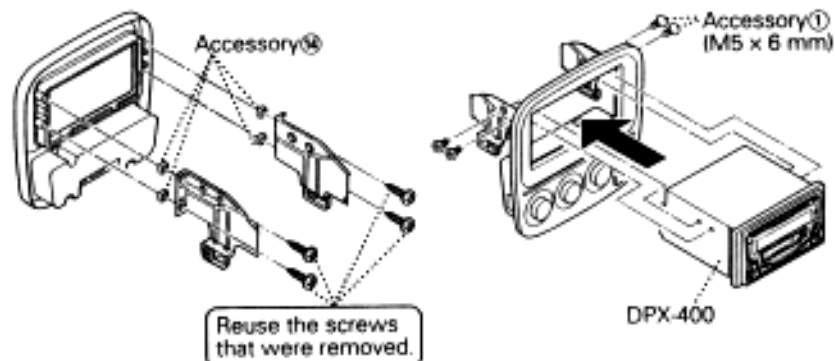

- 3 Install the center panel with the unit in your car.

Troubleshooting guide

What might seem to be a malfunction in your unit may just be the result of slight misoperation or miswiring. Before calling service, first check the following table for possible problems.

PROBLEM	POSSIBLE CAUSE	SOLUTION
The power does not turn on.	The fuse has blown.	After checking for short circuits in the wires, replace the fuse with one with the same rating.
	No ACC position on vehicle ignition.	Connect the same wire to the ignition as the battery wire.
No sound can be heard, or the volume is low.	Attenuator is turned on.	Turn off Attenuator.
	The fader or balance settings are set all the way to one side.	Reset the fader or balance settings.
	The input/output wires or wiring harness are connected incorrectly.	Reconnect the input/output wires or the wiring harness correctly. See the section on "Connecting Wires to Terminals".
	The cassette tape is bad.	Try playing another cassette tape. If works fine, the first tape was bad.
The tape does not go in. / No sound can be heard even though the tape display is made.	The car ignition was turned off during tape eject; or the tape was pulled out during loading, switching the mode to tape mode even though no tape is in.	Press the Eject button.
Nothing happens when the buttons are pressed.	The computer chip in the unit is not functioning normally.	Press the reset button on the unit (see p. 6).
The sound quality is poor or distorted.	The tape head is dirty.	Clean the tape head, referring to the section on "Cleaning the tape head" (see p. 6).
	One of the speaker wires is being pinched by a screw in the car.	Check the speaker wiring.
	The speakers are not wired correctly.	Reconnect the speaker wires so that each output terminal is connected to a different speaker.
Radio reception is poor.	The car antenna is not extended.	Pull the antenna out all the way.
	The antenna control wire is not connected.	Connect the wire correctly, referring to the section on "Connecting Wires to Terminals".

Troubleshooting guide

PROBLEM	POSSIBLE CAUSE	SOLUTION
The memory is erased when the ignition is turned off.	The battery wire has not been connected to the proper terminal.	Connect the wire correctly, referring to the section on "Connecting Wires to Terminals".
	The ignition and battery wire are incorrectly connected.	Connect the wire correctly, referring to the section on "Connecting Wires to Terminals".
A CD ejects as soon as it is loaded.	The CD is upside-down.	Load the CD with the labeled side up.
	The CD is quite dirty.	Clean the CD, referring to the section on "Cleaning CDs" (see p. 7).
The sound skips on a CD.	The CD is scratched or dirty.	Clean the CD, referring to the section on "Cleaning CDs" (see p. 7).
A track will not play.	Random play has been selected.	Turn off random play.

External disc control Mode



PROBLEM	POSSIBLE CAUSE	SOLUTION
The External disc control mode cannot be selected.	No cable has been connected to the disc changer input terminal on the unit.	Connect the cable to the disc changer input terminal on the unit.
	The O-N selection switch of the disc changer is not set properly.	Set the O-N selection switch to "N" position.
The specified disc does not play, but another one plays instead.	The specified CD is quite dirty.	Clean the CD.
	The CD is upside-down.	Load the CD with the labeled side up.
	The disc is loaded in a different slot from that specified.	Eject the disc magazine and check the number for the specified disc.
	The disc is severely scratched.	Try another disc instead.
The sound skips.	Something is touching the disc changer.	Remove whatever is touching it.
	The CD is scratched or dirty.	If skipping happens at the same place when the car is stopped, something with the CD is wrong. Clean the CD.
The display shows that the changer is being played, but no sound can be heard.	The computer chip in the unit is not functioning normally.	Press the reset button on the unit (see p. 6).
The specified track will not play.	Random play or magazine random play has been selected.	Turn off random play or magazine random play.

If the following situations, consult your nearest service center:

- Even though the disc changer is connected, the Disc Changer Mode is not on, with "AUX INPUT" showing in the display during the Changer Mode.
- Even though no device (KCA-S210A, CA-C1AX, KDC-CPS82 or KDC-CX82) is connected, the AUX Mode is entered when switching modes.

Troubleshooting guide

The following messages are displayed when certain problems are occurring in your system. Take the recommended actions.

- | | |
|---|--|
| Eject | No disc magazine has been loaded in the changer. The disc magazine is not completely loaded.
⇒ Load the disc magazine properly. |
| No Disc | No disc has been loaded in the disc magazine.
⇒ Load a disc into the disc magazine. |
| Error 04 | No disc has been loaded in the disc magazine.
⇒ Load a disc into the disc magazine.
The CD is quite dirty. The CD is upside-down. The CD is scratched a lot.
⇒ Clean the CD and load it correctly. |
| Blank | Nothing has been recorded on the MD.
⇒ The next MD will automatically be played. |
| No Track | No tracks are recorded on the MD, although it has a title.
⇒ The next MD will automatically be played. |
| Error 77/
Error 99 | Something is wrong with the disc magazine. Or the unit is malfunctioning for some reason.
⇒ Check the disc magazine. And then, press the reset button on the unit.
If the "Error 77" "Error 99" code does not disappear, consult your nearest service center. |
| Error 30 | The faceplate of the slave unit being connected to this unit has been removed.
⇒ Replace it. |
| Hold | The protective circuit in the unit activates when the temperature inside the automatic disc changer exceeds 60°C (140°F), stopping all operation.
⇒ Cool down the unit by opening the windows or turning on the air conditioner. As the temperature falls below 60°C (140°F), the disc will start playing again. |
| No Title | An attempt was made to display the track/disc title of the MD disc during play, but the MD has no titles. |
| No Text | An attempt was made to display the CD text of the CD being played but it has no titles. |
| No Name | <ul style="list-style-type: none">• An attempt was made to display the name of the station being received but it was not set in memory.• An attempt was made to display the name of the disc being played but it was not set in memory.• An attempt was made to display the station name/disc name after the battery had been removed for a long period. |
|  | The tape player is malfunctioning.
⇒ Eject the tape and try inserting it again.
Contact the Kenwood dealer if this indicator continues blinking or the tape cannot be ejected. |
|  | The CD player is malfunctioning.
⇒ Eject the CD and try inserting it again.
Contact the Kenwood dealer if this indicator continues blinking or the CD cannot be ejected. |

Specifications

Specifications subject to change without notice.

FM tuner section

Frequency range (200 kHz space)	87.9 MHz – 107.9 MHz
Usable sensitivity (S/N = 30dB)	9.3dBf (0.8 μ V/75 Ω)
Quieting Sensitivity (S/N = 50dB)	15.2dBf (1.6 μ V/75 Ω)
Frequency response (\pm 3.0 dB)	30 Hz – 15 kHz
Signal to Noise ratio (MONO)	70 dB
Selectivity (\pm 400 kHz)	\geq 80 dB
Stereo separation (1 kHz)	40 dB

AM tuner section

Frequency range (10 kHz space)	530 kHz – 1700 kHz
Usable sensitivity (S/N = 20dB)	28 dB μ (25 μ V/75 Ω)

Cassette player section

Tape speed	4.76 cm/sec.
Wow & Flutter (WRMS)	0.08 %
Frequency response (70 μ s)	25 Hz – 22 kHz (\pm 3 dB)
Separation (1 kHz)	40 dB
Signal to Noise ratio	
(Dolby NR OFF)	60 dB
(Dolby B NR ON)	68 dB

CD player section

Laser diode	GaAlAs (λ =780 nm)
Digital filter (D/A)	8 Times Over Sampling
D/A Converter	1 Bit
Spindle speed	500 – 200 rpm (CLV)
Wow & Flutter	Below Measurable Limit
Frequency response (\pm 2 dB)	20 Hz – 20 kHz
Total harmonic distortion (1 kHz)	0.5 %
Signal to Noise ratio	93 dB (1 kHz)
Dynamic range	96 dB
Channel separation	85 dB

Audio section

Maximum output power	40 W \times 4
Full bandwidth power (at less than 1% THD)	20 W \times 4
Tone action	
Bass:	100 Hz \pm 10 dB
Treble:	10 kHz \pm 10 dB
Preout level / Load	1500mV/10k Ω
Preout impedance	\leq 600 Ω

General

Operating voltage	14.4 V (11 – 16 V allowable)
Current consumption	10.0 A at Rated power
Installation size (W \times H \times D)	178 \times 100 \times 155 mm
	7 \times 3-15/16 \times 6-1/8 in.
Weight	2.6 kg